

# CRASH

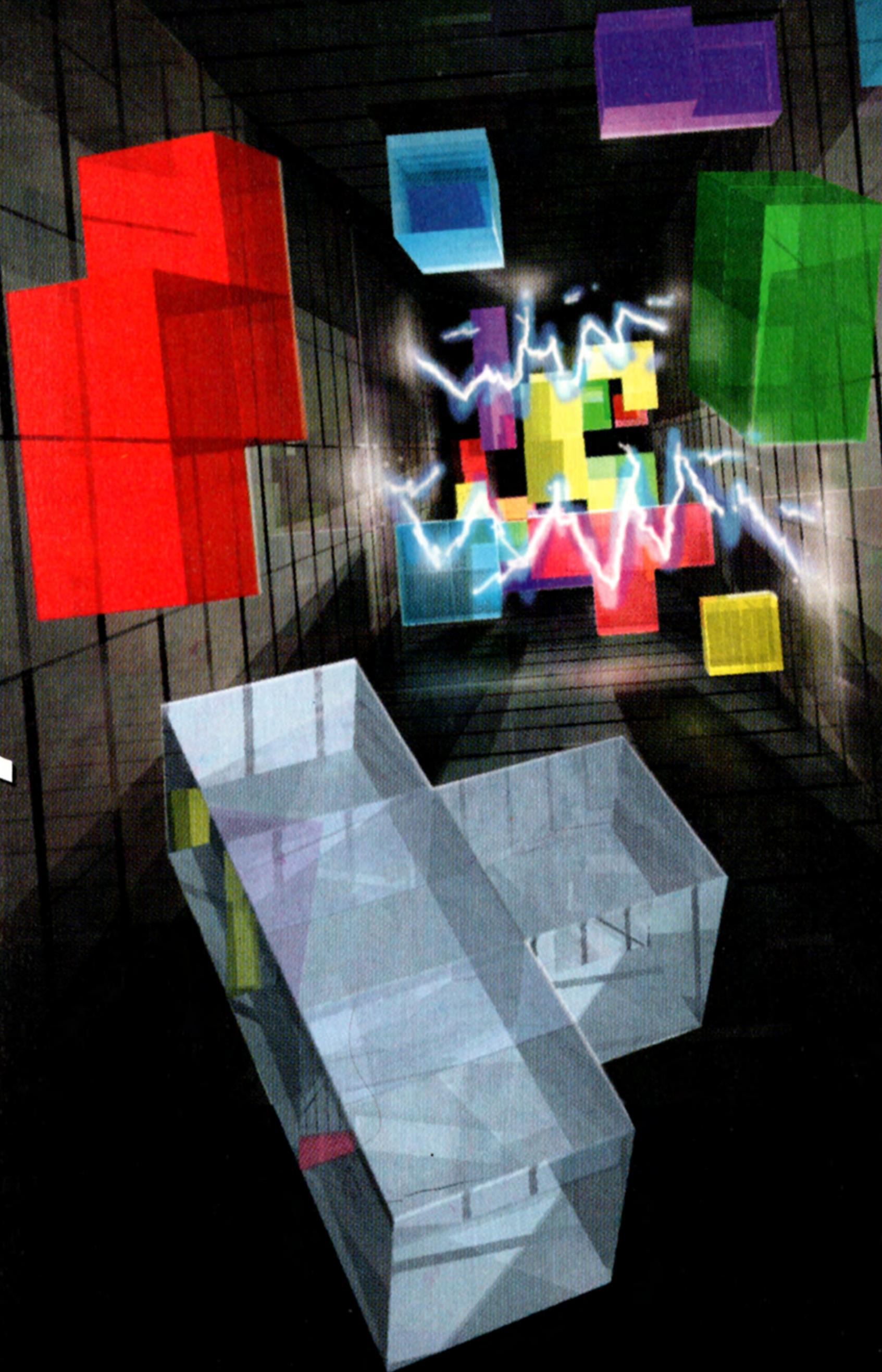

NTSC U/C

# PlayStation™



SLUS-00024



## **WARNING: READ BEFORE USING YOUR PlayStation™ GAME CONSOLE**

A very small percentage of individuals may experience epileptic seizures when exposed to certain light patterns or flashing lights. Exposure to certain patterns or backgrounds on a television screen or while playing video games, including games played on the PlayStation game console, may induce an epileptic seizure in these individuals. Certain conditions may induce previously undetected epileptic symptoms even in persons who have no history of prior seizures or epilepsy. If you, or anyone in your family, has an epileptic condition, consult your physician prior to playing. If you experience any of the following symptoms while playing a video game — dizziness, altered vision, eye or muscle twitches, loss of awareness, disorientation, any involuntary movement, or convulsions — IMMEDIATELY discontinue use and consult your physician before resuming play.

## **WARNING TO OWNERS OF PROJECTION TELEVISIONS**

Still pictures or images may cause permanent picture-tube damage or mark the phosphor of the CRT. Avoid repeated or extended use of video games on large-screen projection televisions. Refer to your projection TV instruction manual for more details.

## **Handling Your PlayStation DISC**

- This compact disc is intended for use only with the PlayStation game console.
- Do not bend it, crush it or submerge it in liquids.
- Do not leave it in direct sunlight or near a radiator or other source of heat.
- Be sure to take an occasional rest break during extended play.
- Keep this compact disc clean. Always hold the disc by the edges and keep it in its protective case when not in use.
- Clean the disc with a lint-free, soft, dry cloth, wiping in straight lines from center to outer edge. Never use solvents or abrasive cleaners.

# GEOM CUBE™

## CONTENTS

Starting Up	■ ■ ■ ■ ■ ■ ■ ■	2
Controls	■ ■ ■ ■ ■ ■ ■ ■ ■ ■	3
How to Play	■ ■ ■ ■ ■ ■ ■ ■	4
Configuration	■ ■ ■ ■ ■ ■ ■ ■	5
1 Player Mode	■ ■ ■ ■ ■ ■ ■ ■	6
2 Player Mode	■ ■ ■ ■ ■ ■ ■ ■	7
Geom Fighters	■ ■ ■ ■ ■ ■ ■ ■	8
Software Warranty	■ ■ ■ ■ ■ ■	9

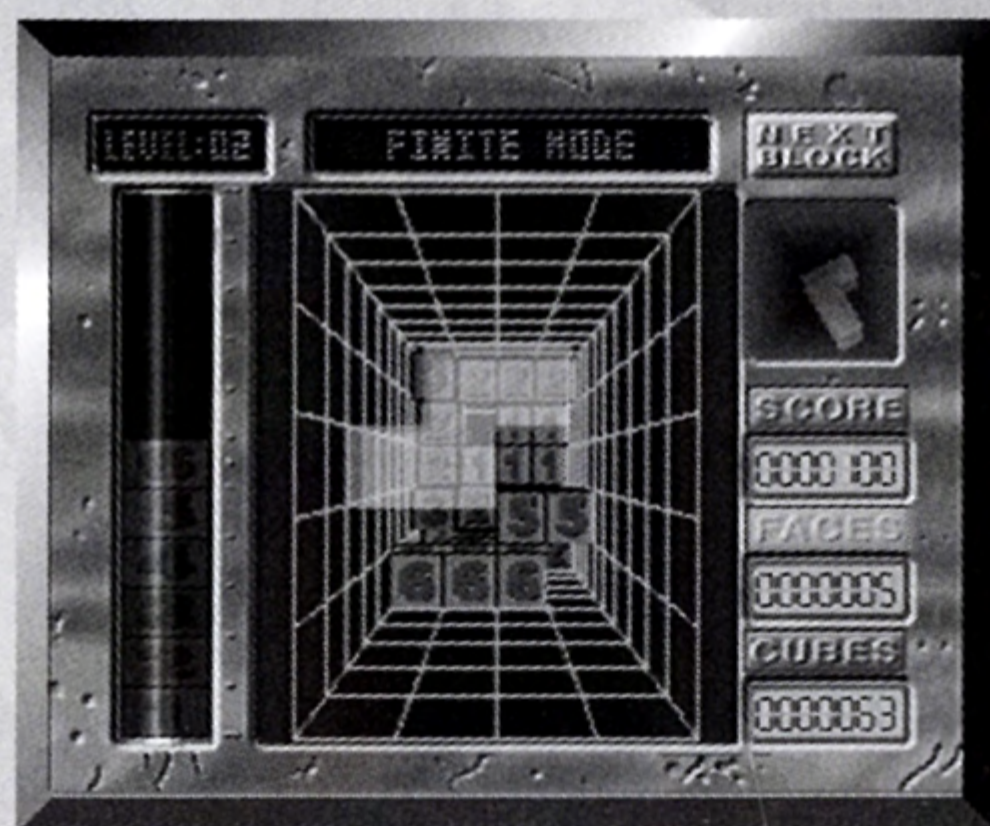
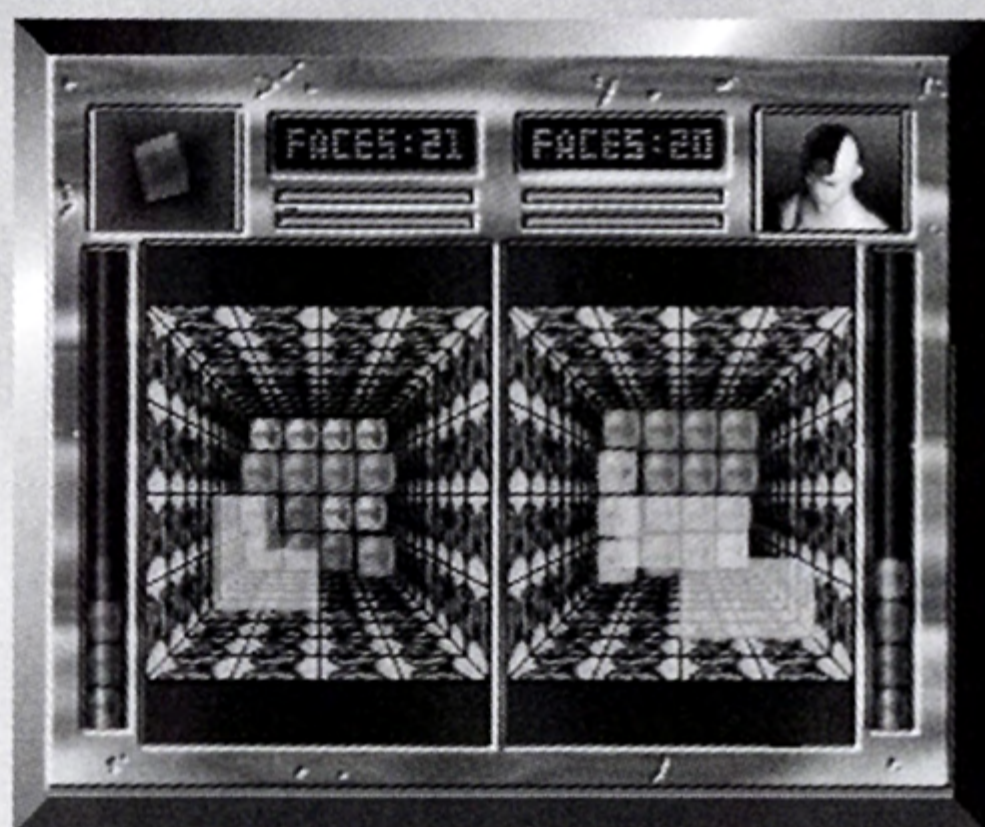

2

# STARTING UP

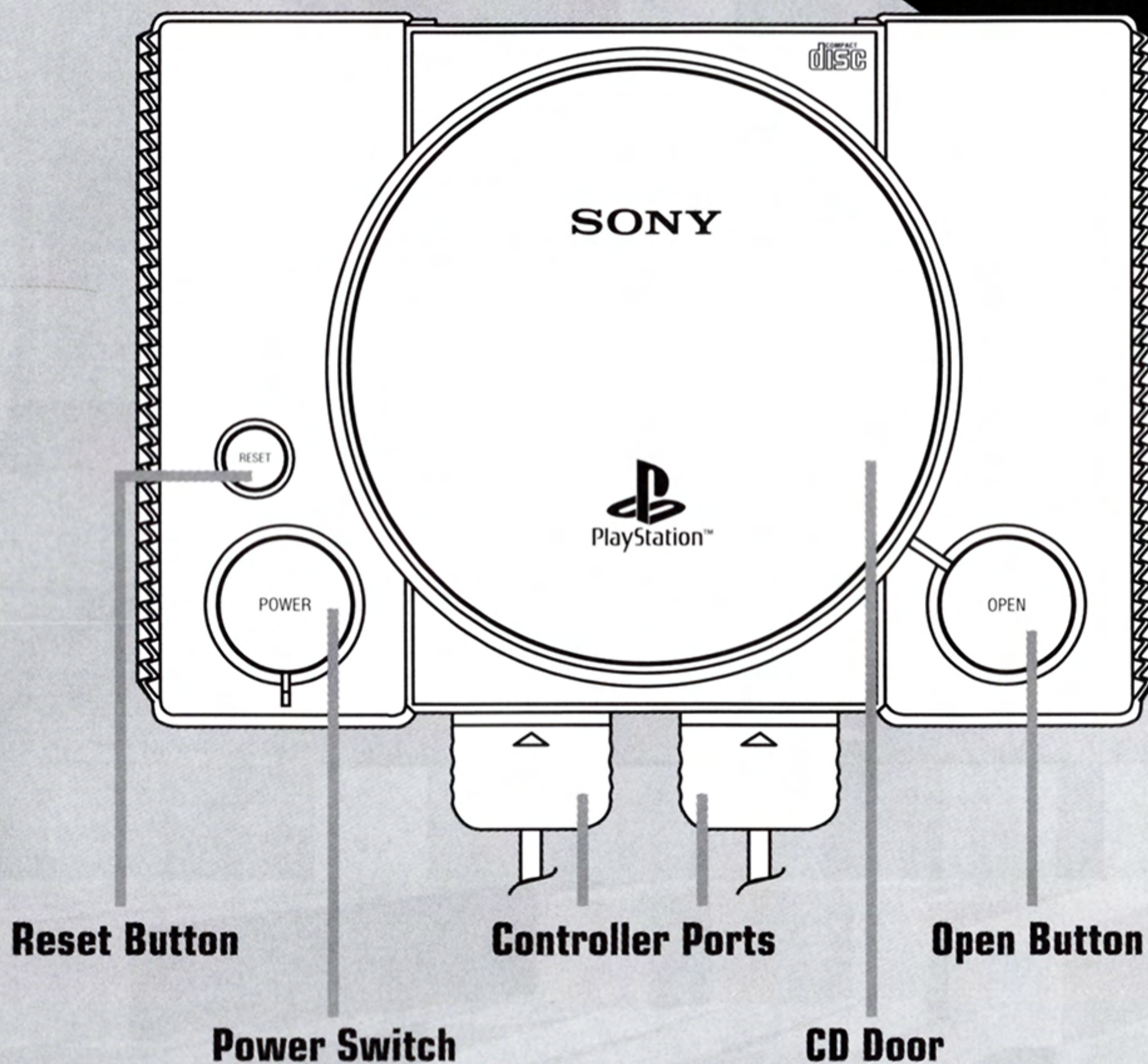

1. Set up your PlayStation game console according to the instructions in its Instruction Manual.
2. Place the **GEOM CUBE™** disc into the PlayStation game console, close the CD Door and press the button marked "POWER" to turn the game console ON.  
**Note:** Make sure the PlayStation game console's power is OFF before inserting or removing a compact disc.
3. The game contains a demonstration mode which may help first-time players see how the game is played.
4. Press the START Button to enter the Mode Select Screen. See page 4 for more information.

# CONTROLS

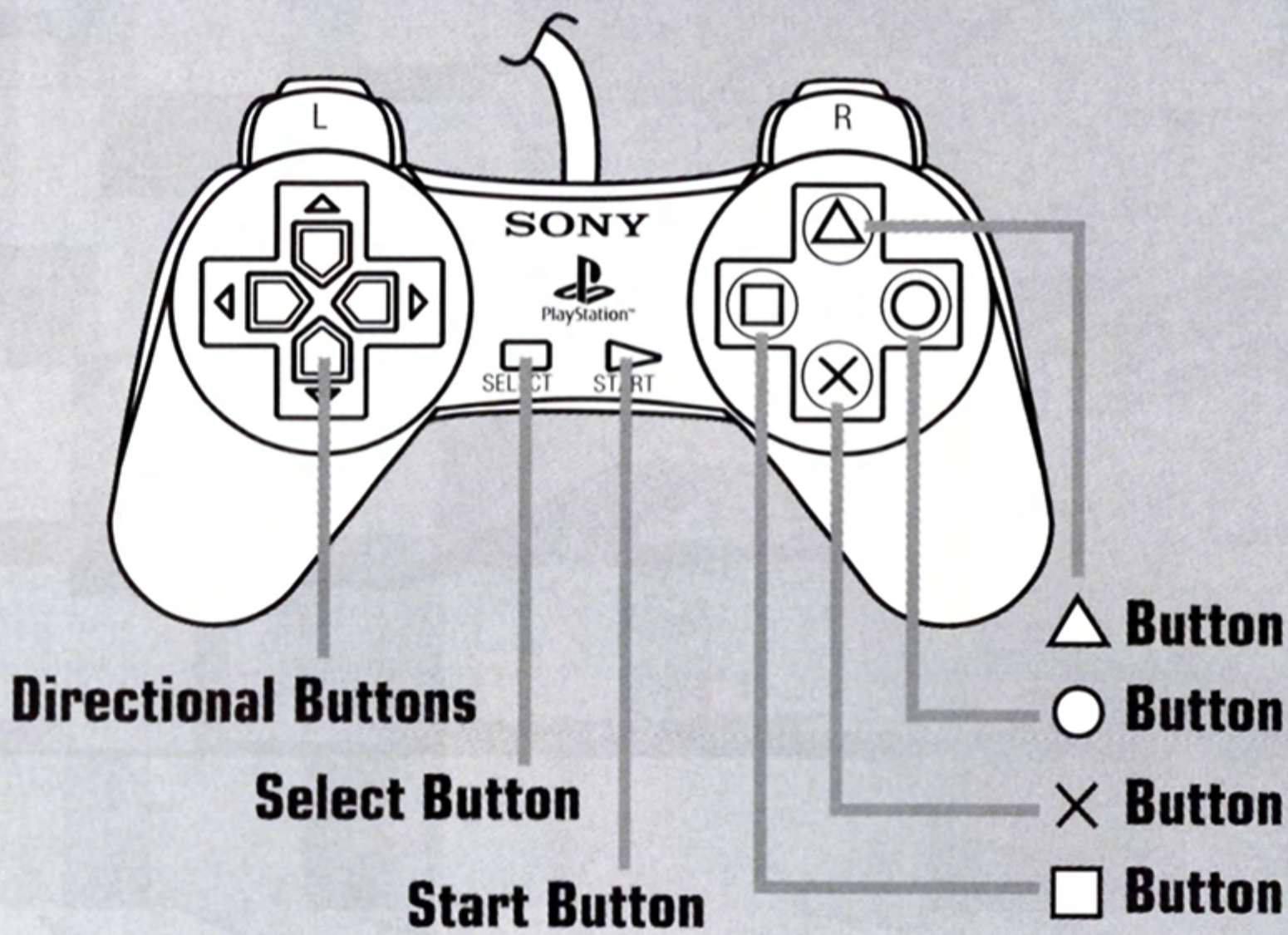
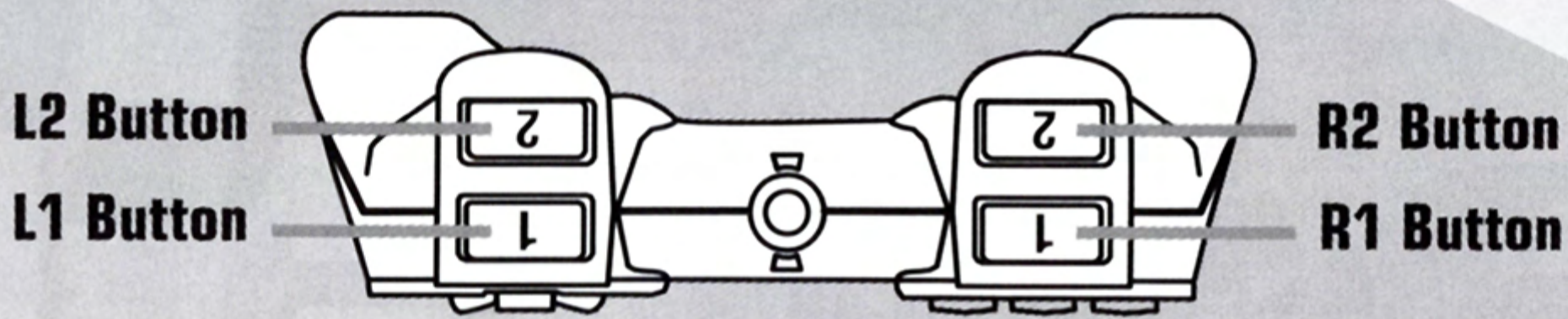

**Note:** These are the standard terms used to describe the different controller buttons. The controls for playing the game can be configured to use different button combinations, (see page 5) but in general, the Directional Buttons UP, DOWN, LEFT and RIGHT are used to move the blocks and the  $\triangle$   $\circ$   $\times$  +  $\square$  Buttons are used to rotate and drop the blocks in position.

Press the START Button to pause play and press again to continue.

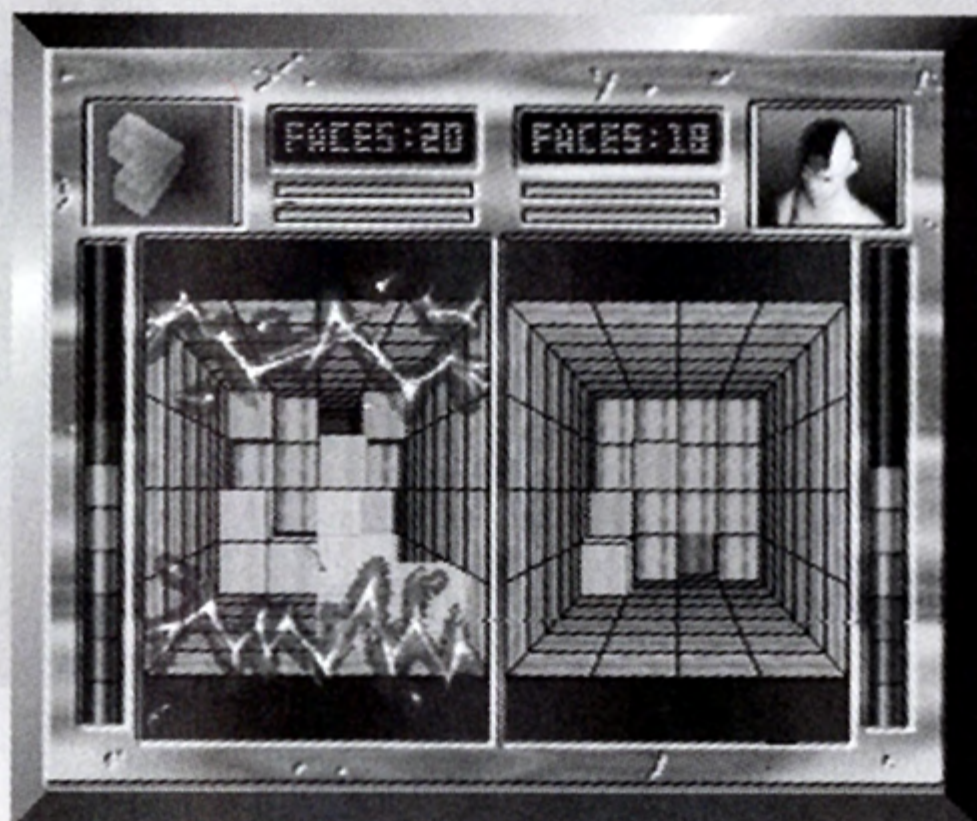

# HOW TO PLAY

**GEOM CUBE** is a simple game in which you control 3 dimensional block shapes that are made up of 1-5 cubes. The objective is to maneuver the blocks into a rectangular pit, fitting the blocks together and making sure to use all available space.

When the blocks are arranged and no empty spaces are left on a level, that level (or Face) will disappear. If all faces in the pit are eliminated, the player receives a special bonus.

There are 24 different block shapes of varying complexity – from very simple to very complex. If the blocks are not arranged in a way to fill in all the spaces, they will build up and reach the top of the pit. When the layers build up near the top of the pit, lightning will flash to warn you of your situation. If the blocks reach the top, the game ends.

**NOTE:** It is important to avoid leaving any empty spaces in the pit.

## MODE SELECT SCREEN

Using the Directional Buttons up/down, select from 1 Player, 2 Player, or Configuration and press the X Button to select a play mode.

**1 PLAYER MODE:** For single player mode, you can choose between three different types:

**1 Player vs CPU**

**1 Player Finite Mode** (See page 6 for more information.)

**1 Player Infinite Mode** (See page 7 for more information.)

**2 PLAYER MODE:** This mode allows two players to play against each other.

**NOTE:** A 2 Player game can be started from within a 1 Player game at any time by pressing the START Button on the second controller.





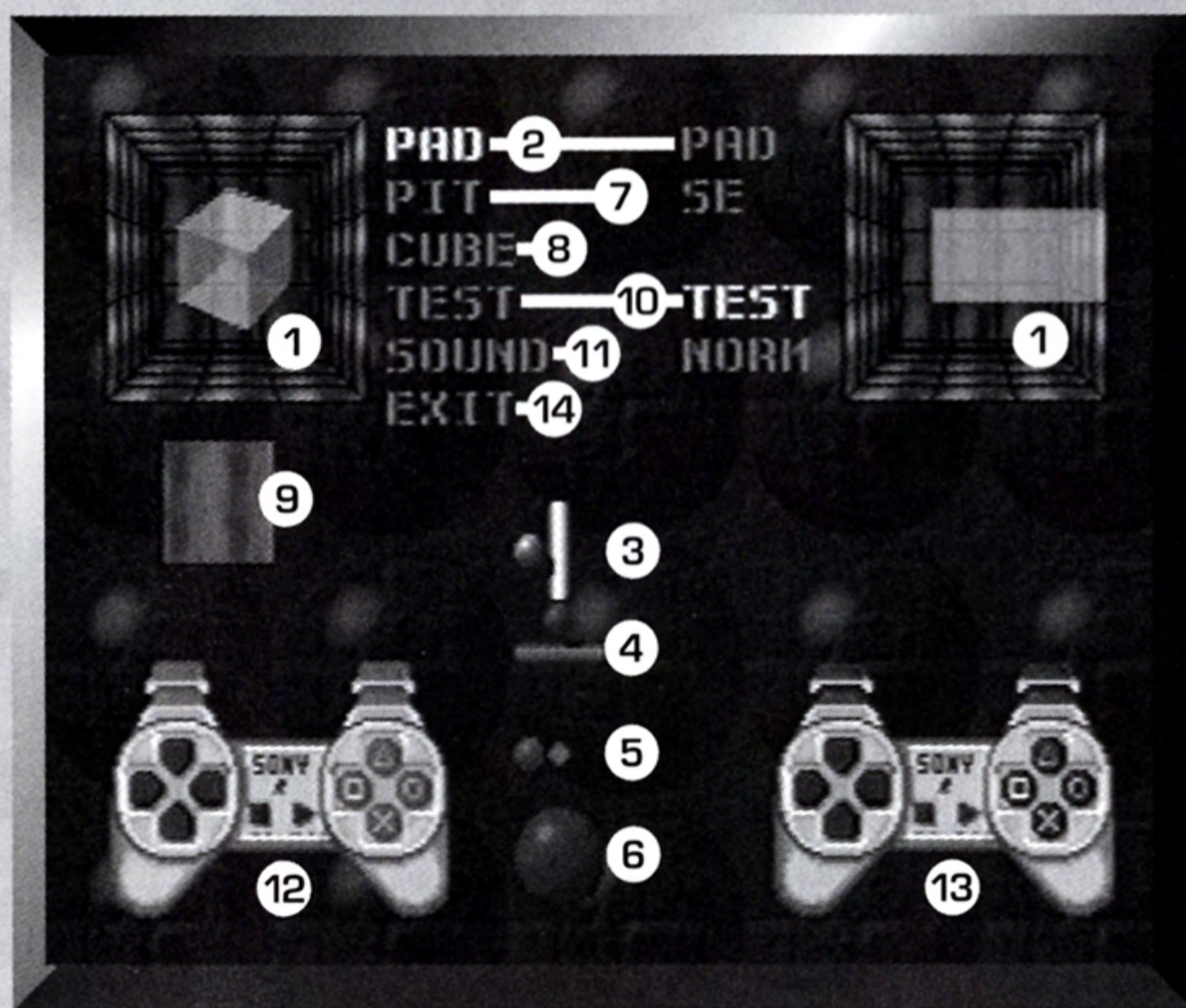

The configuration screen allows the player to change play conditions including button settings, colors and sound options.

Press the UP or DOWN Directional Buttons to select different options and press LEFT or RIGHT to change options.

# CONFIGURATION



- 1) **Test Pit:** see the results of your color choices and test your controller options here
- 2) **Controller Configuration:** press one of the     Buttons or the L1, L2, R1 or R2 Buttons to define each of the following:
  - 3) **X:** block rotation on "X" axis
  - 4) **Y:** block rotation on "Y" axis
  - 5) **Z:** block rotation on "Z" axis
  - 6) **Drop:** drops the block to the bottom of the pit
- 7) **Pit:** choose from a variety of pit colors and patterns
- 8) **Cube:** select different colors for the blocks
- 9) **Test Cube:** see the results of your cube color options here
- 10) **Test:** select this to try out your controller options
- 11) **Sound:** choose between STEREO and MONO sound
- 12) **Control 1:** controller layout for 1 Player
- 13) **Control 2:** controller layout for second player
- 14) **Exit:** select this to return to the Mode Select Screen

# 1 PLAYER MODE

The 1 Player mode allows you to choose between 3 different game modes.

**1 Player vs CPU:** You play against a computer controlled GEOM FIGHTER.

The objective is to beat the computer in a head-to-head competition. Each player must eliminate the same number of faces as well as place the same blocks into the pit. When a face is eliminated, that face is added or "thrown" to the other player's pit, forcing that player closer to the top of the pit. There are two ways to win: Force your opponent to the top of their pit or be the first to eliminate 21 faces. You must defeat the first character then move onto the remaining characters

**1 Player Finite:** The objective is to clear each round. When a round is cleared, the player moves on to the next round. You may chose to start at round 1, 20, or 50. Each round may contain different pit sizes or block shapes. Each round also gets progressively more difficult. There is a total of 99 rounds in Finite Mode.

**1 Player Infinite:** You start play within the pit that you choose. The player has the choice between three different pit sizes (3x3x11, 4x4x11, and 5x6x11). The objective of this game is to score as many points as possible. As the game progresses, it becomes increasingly difficult and the block shapes become more complex.

## 1 PLAYER SCREEN

- 1) Level of difficulty
- 2) Message window
- 3) Status of pit (how close the blocks are to the top)
- 4) Play pit
- 5) Next block
- 6) Player's score
- 7) Faces/layers left to eliminate
- 8) Total number of cubes used

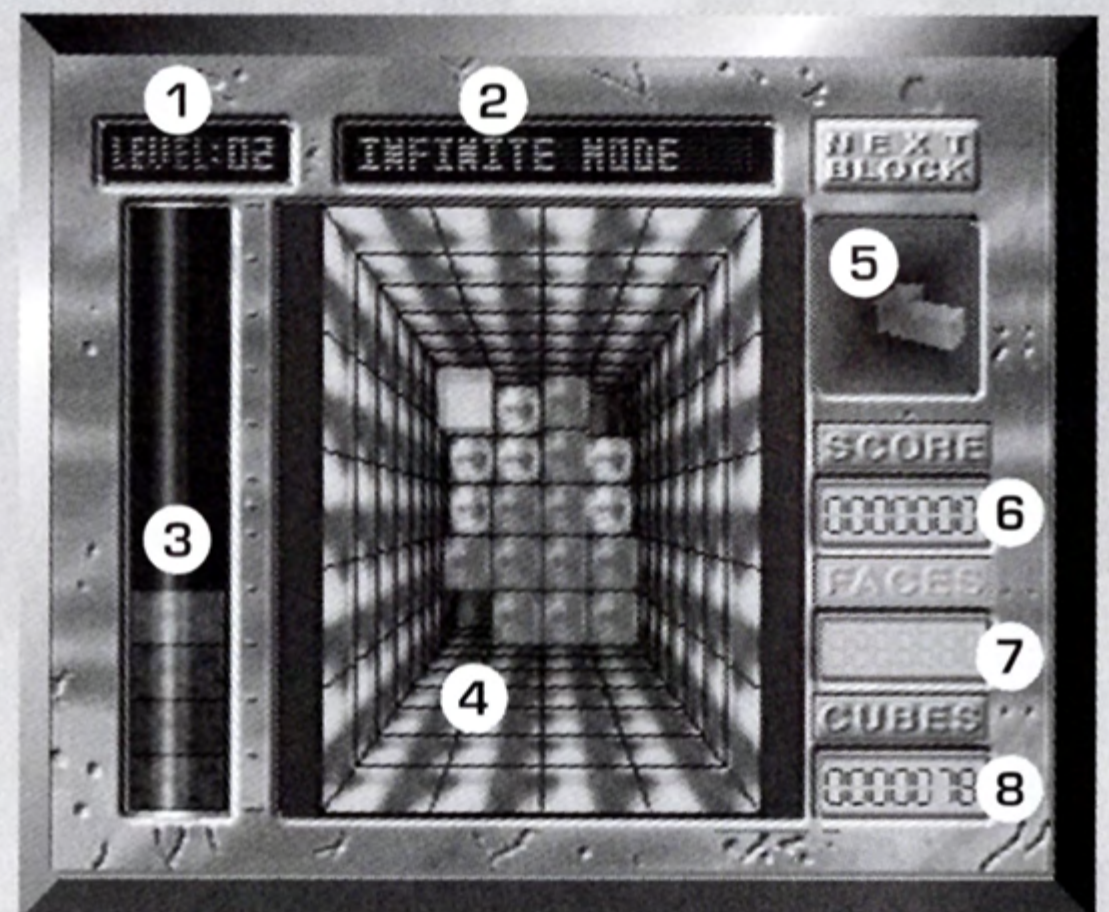



# 2 PLAYER MODE

Two player mode is a split screen game in which you compete against another player with his or her own controller.

The 2 player game is similar to the 1 Player vs CPU game. The objective is to beat the opposing player in a head-to-head competition. Each player is given the same blocks to place within the pit and must eliminate the same number of Faces (21). When a Face is eliminated, that Face is added or "thrown" to the other player's pit, forcing that player closer to the top of his/her pit. There are two ways to win: Force your opponent to the top of their pit, or be the first to eliminate 21 faces.

## 2 PLAYER SCREEN

- 1) Next block for Player 1
- 2) Faces left to eliminate for Player 1
- 3) Faces left to eliminate for Player 2
- 4) Next block for Player 2
- 5) Status of pit for Player 1
- 6) Play pit for Player 1
- 7) Play pit for Player 2
- 8) Status of pit for Player 2

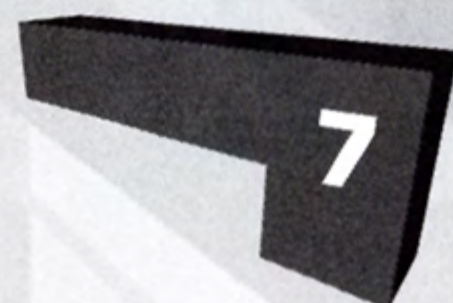
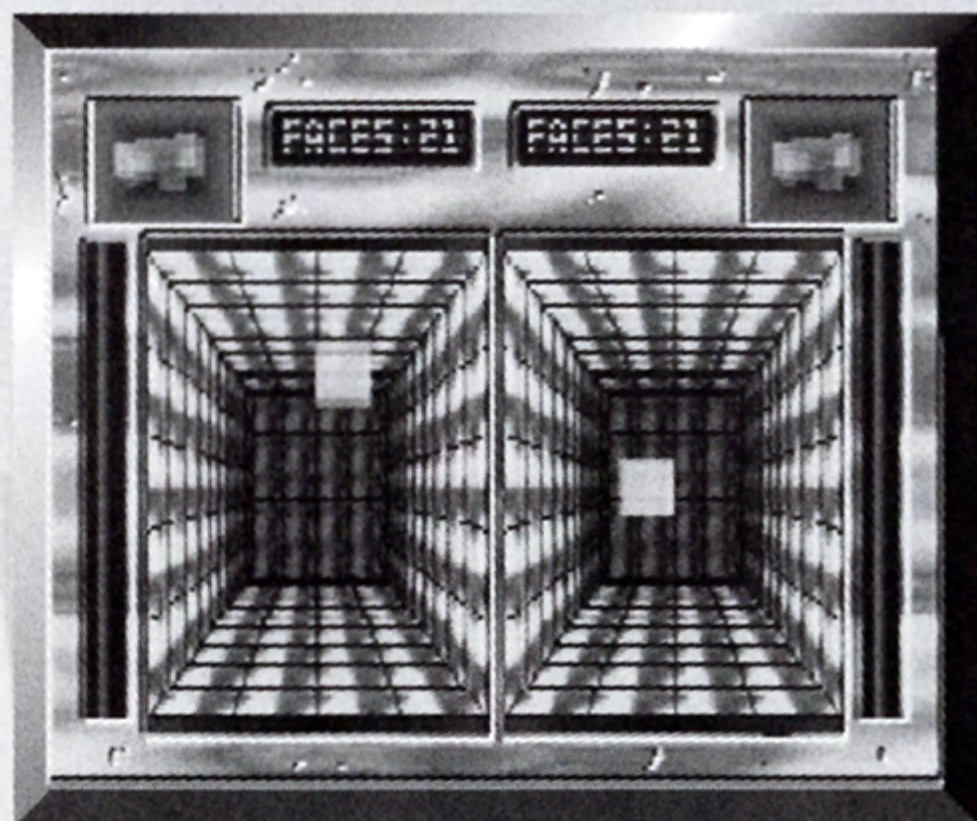
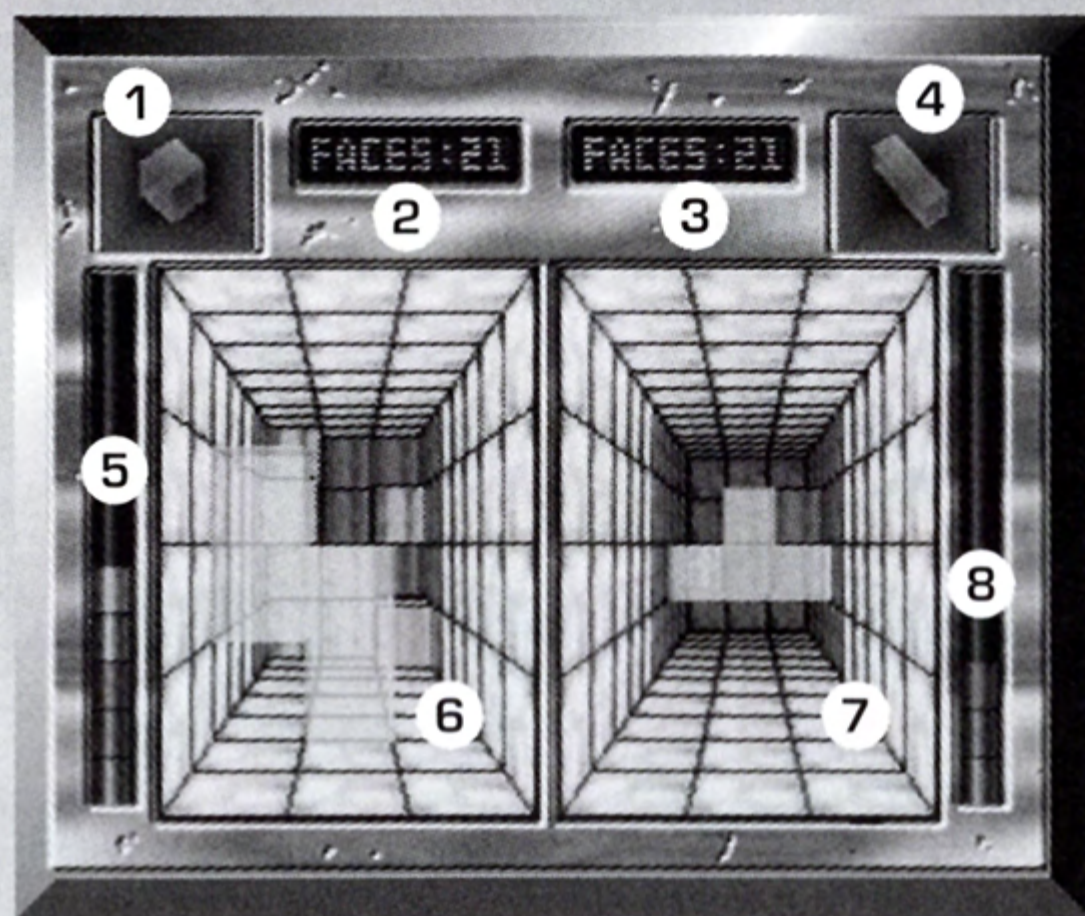

# GEOM FIGHTERS

In a 1 Player Game, you must battle each of the Geom Fighters in sequence to become the new Geom Master.

**Geom Fighter Core:** An android that plays with precision and efficiency.

**Geom Fighter KI.IRIN:** A mysterious fighter whose tricky moves can be devastating.

**Geom Fighter Zone:** You might feel as if you're winning until this robot executes a crucial move at the perfect time.

**Geom Fighter Lisa:** You may not understand the pattern to her movements, but you will feel the results.

**Geom Prince Keith:** His combination of intellect and aggressiveness often leads to victory.

**Geom Queen Maria:** Her unpredictable playing style may confuse her opponents, granting her the upper hand.

**Geom King Gear:** His method is simple and straightforward – strong, aggressive and merciless.

**Geom Master Alderan:** This master of the blocks knows all the moves – can you defeat him and claim his title?

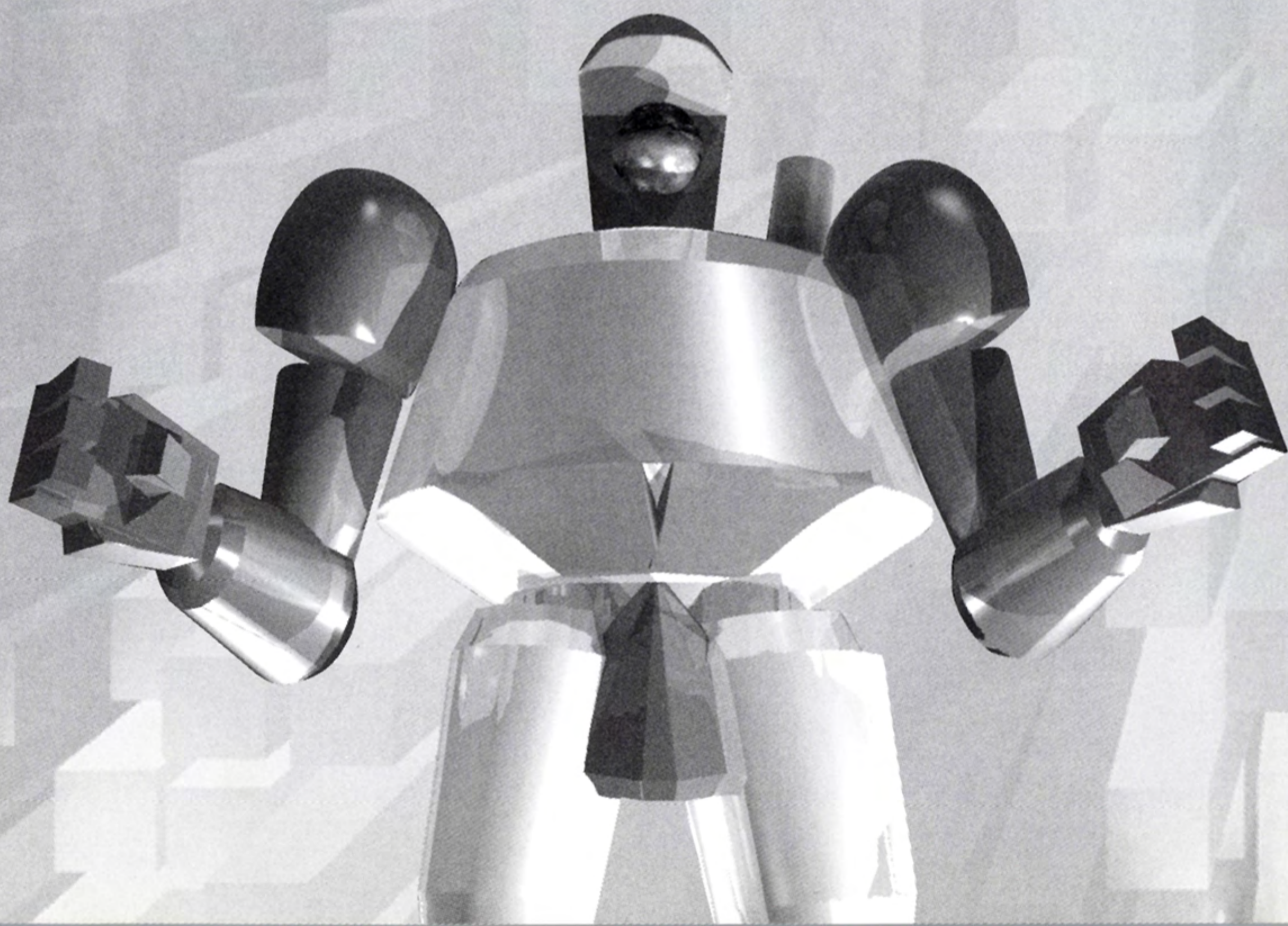

# SOFTWARE WARRANTY

American Technos warrants to the original purchaser of this product that this Compact Disc is free from defects in material and workmanship for a period of ninety (90) days from the date of purchase. American Technos agrees for a period of ninety (90) days to either repair or replace, at its option, the American Technos product.

This warranty shall not be applicable and shall be void if the defect in the American Technos product has arisen through abuse, unreasonable use, mistreatment or neglect. THIS WARRANTY IS IN LIEU OF ALL OTHER WARRANTIES AND NO OTHER REPRESENTATIONS OR CLAIMS OF ANY NATURE SHALL BE BINDING ON OR OBLIGATE AMERICAN TECHNOS. ANY IMPLIED WARRANTIES APPLICABLE TO THIS SOFTWARE PRODUCT, INCLUDING WARRANTIES OF MERCHANTABILITY AND FITNESS FOR A PARTICULAR PURPOSE, ARE LIMITED TO THE NINETY (90) DAY PERIOD DESCRIBED ABOVE. IN NO EVENT WILL AMERICAN TECHNOS BE LIABLE FOR INCIDENTAL OR CONSEQUENTIAL DAMAGES RESULTING FROM POSSESSION, USE OR MALFUNCTION OF THE AMERICAN TECHNOS SOFTWARE PRODUCT.

Some states do not allow limitations as to how long an implied warranty lasts and/or exclusions or limitations of consequential damages, so the above limitations and/or exclusions of liability may not apply to you. This warranty gives you specific legal rights, and you may also have other rights which vary from state to state.

# GEOM CUBE™

Watch for more new & exciting  
PlayStation titles coming soon  
from American Technos!



**TECHNOS**  
AMERICAN TECHNOS INC.



American Technos, Inc. 2010 North First Street, Suite 500, San Jose, CA 95131

Geom Cube is a trademark of American Technos, Inc. © 1995 Technos Japan Corporation. Licensed exclusively to American Technos, Inc. Licensed by Sony Computer Entertainment America for use with the PlayStation game console. PlayStation and the PlayStation Logos are trademarks of Sony Computer Entertainment Inc. The ratings icon is a registered trademark of the Interactive Digital Software Association. Manufactured and printed in U.S.A.

THIS SOFTWARE IS COMPATIBLE WITH PLAYSTATION GAME CONSOLES WITH THE NTSC U/C DESIGNATION.

™ U.S. and foreign patents pending.